

FINAT

2024

PROMO INDUSTRIA 2024
Scadenza promozione
31.12.2024

ITERIA 2000 INCORPORATE MOVINT

QUALITÀ FINAT

€ 85,31

€ 70,16

€ 86,53

€ 164,00

€ 17,99

€ 22,69



PINZA TP

PER TRASPORTO VERTICALE



ART.	CODICE	PORTATA kg	APERTURA mm	PESO kg	PREZZO
TP 3/4	199056	750	0 - 13	1,6	€ 384,07
TP 1 1/2	199063	1500	0 - 22	7,0	€ 535,73
TP 3	199032	3000	0 - 30	15,0	€ 794,61



PINZA TPS

PER TRASPORTO VERTICALE E ORIZZONTALE



ART.	CODICE	PORTATA kg	APERTURA mm	PESO kg	PREZZO
TPS 3/4	199025	750	0 - 13	2,0	€ 557,45
TPS 1 1/2	199407	1500	0 - 22	8,0	€ 749,82
TPS 3	199759	3000	0 - 30	17,0	€ 1.038,21



PINZA PO

PRESA ORIZZONTALE LAMIERA SINGOLA
Da utilizzare in coppia



ART.	CODICE	PORTATA SINGOLA kg	APERTURA mm	PESO kg	PREZZO SINGOLA
PO 500	196871	500	0 - 60	6,0	€ 331,14
PO 1500	196888	1500	0 - 60	8,0	€ 381,70
PO 3000	196895	3000	0 - 60	12,0	€ 432,25

PINZA SVC

PER TRASPORTO VERTICALE
CON CHIUSURA AUTOMATICA



ART.	CODICE	PORTATA kg	APERTURA mm	PESO kg	PREZZO
SVC 0.5	223485	500	0 - 19	1,6	€ 297,96
SVC 1	223492	1000	0 - 25	3,2	€ 368,36
SVC 2	223508	2000	0 - 32	6,0	€ 527,46
SVC 3	223515	3000	0 - 38	9,0	€ 706,50



PINZA SCC

CON VITE DI PRESSIONE



ART.	CODICE	PORTATA kg	APERTURA mm	PESO kg	PREZZO
SCC - 0,5	150644	500	0 - 28	0,8	€ 317,57
SCC - 1	202060	1000	0 - 30	3,0	€ 374,79
SCC - 1,5	156707	1500	0 - 32	4,0	€ 471,54
SCC - 3	159371	3000	0 - 50	6,0	€ 691,71

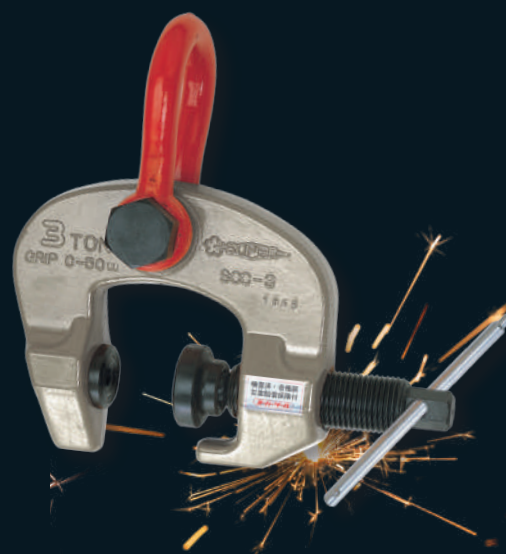

PINZA TPS-P

PER TRASPORTO LAMIERE
DELICATE O LUCIDE - INOX



ART.	CODICE	PORTATA kg	APERTURA mm	PESO kg	PREZZO
TPS - 0,5P	205511	500	1 - 20	5,5	€ 868,57
TPS - 1P	207232	1000	1 - 30	6,5	€ 1.080,28
TPS - 2P	199704	2000	1 - 50	14,0	€ 1.501,68





UNCINO HHCPJ

UNCINO PER SOLLEVAMENTO

Protezione in gomma antigraffio.

DA UTILIZZARE IN COPPIA

ART.	CODICE	PORTATA SINGOLA kg	APERTURA mm	PESO kg	PREZZO SINGOLA
HHCPJ 3	212458	1500	40	3,0	€ 150,71
HHCPJ 6	212465	3000	50	5,0	€ 228,00
HHCPJ 12	212472	6000	70	11,5	€ 364,39

STAFFE SPT

TUBOLARI PER PACCHI DI LAMIERE

DA UTILIZZARE IN COPPIA

ART.	CODICE	PORTATA COPPIA kg	PASSO mm	PESO kg	PREZZO SINGOLA
SPT 0,5	224666	500	190	2,0	€ 352,18
SPT 1	224130	1000	220	2,5	€ 418,34
SPT 1,5	224673	1500	250	3,5	€ 469,57
SPT 2	224680	2000	300	6,0	€ 616,48

STAFFE SP

PER PACCHI DI LAMIERE

PER SOLLEVAMENTO ORIZZONTALE

DA UTILIZZARE IN COPPIA

ART.	CODICE	PORTATA COPPIA kg	PASSO mm	PESO COPPIA kg	PREZZO COPPIA
SP 3	186209	3000	1000	30,0	€ 1.501,71
SP 5	186216	5000	1000	56,0	€ 1.656,00
SP 5A	186230	5000	1250	59,0	€ 1.730,57

* TIRANTI ESCLUSI

PINZA TPSJ

PER TRASPORTO VERTICALE E LATERALE

ART.	CODICE	PORTATA kg	APERTURA mm	PESO kg	PREZZO
TPSJ 3/4	206938	750	0 - 15	2,0	€ 70,16
TPSJ 1	224611	1000	0 - 20	5,0	€ 94,05
TPSJ 1½	206945	1500	0 - 20	6,0	€ 129,45
TPSJ 2	224628	2000	0 - 25	8,0	€ 162,84
TPSJ 3	206952	3000	0 - 30	13,0	€ 299,55



PINZA PO-N

PRESA ORIZZONTALE LAMIERA SINGOLA
BASE RIDOTTA

Da utilizzare in coppia

ART.	CODICE	PORTATA SINGOLA kg	APERTURA mm	PESO kg	PREZZO SINGOLA
PO-N 1	215107	500	0 - 100	7,5	€ 161,04
PO-N 2	215121	1000	0 - 100	9,5	€ 234,00
PO-N 3	215138	1500	0 - 100	12,0	€ 272,25



PINZA PO-MS

PRESA ORIZZONTALE LAMIERA SINGOLA
CHIUSURA A SCATTO

Da utilizzare in coppia

ART.	CODICE	PORTATA SINGOLA kg	APERTURA mm	PESO kg	PREZZO SINGOLA
PO-MS 1,5	224635	750	0 - 25	2,5	€ 55,85
PO-MS 3	224642	1500	0 - 30	4,0	€ 101,24
PO-MS 5	224659	2500	0 - 45	6,0	€ 153,42





PINZA RJ

PER LA MANIPOLAZIONE DEI TONDI

ART.	CODICE	PORTATA kg	APERTURA mm	PESO kg	PREZZO
RJ 1	209618	1000	50 - 100	4,5	€ 253,29
RJ 2	209632	2000	80 - 130	14,0	€ 518,79
RJ 3	209649	3000	120 - 220	32,0	€ 847,28



PINZA HLC-U

PER SOLEVAMENTO LAMIERE STRUTTURE E TRAVI
CHIUSURA A SCATTO



ART.	CODICE	PORTATA kg	APERTURA mm	PESO kg	PREZZO
HLC 0,5 U	222235	500	0 - 25	3,2	€ 368,36
HLC 1U	204057	1000	0 - 30	5,1	€ 454,82
HLC 2U	222242	2000	0 - 35	8,7	€ 584,04
HLC 3U	222334	3000	0 - 45	13,5	€ 727,07

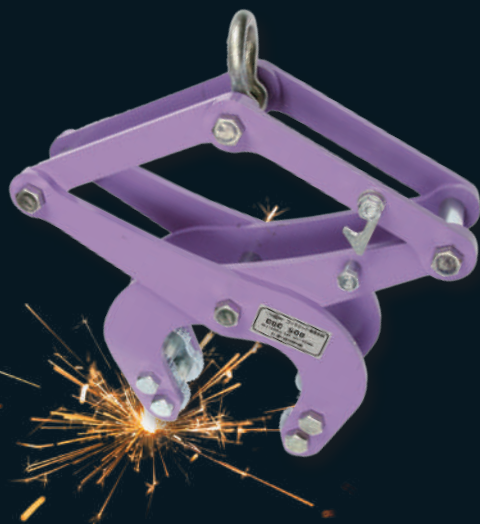

PINZA CGC

PER MANUFATTI/BLOCCHI



ART.	CODICE	PORTATA kg	APERTURA mm	PESO kg	PREZZO
CGC-250	211437	250	30 - 160	7,0	€ 303,75
CGC-500	209298	500	30 - 160	12,0	€ 594,64

PINZA CGC-N

PER MANUFATTI/BLOCCHI
SUPERFICI DI PRESA PROTETTE



ART.	CODICE	PORTATA kg	APERTURA mm	PESO kg	PREZZO
CGC-250N	212564	250	30 - 140	7,0	€ 352,93
CGC-500N	214988	500	30 - 140	13,0	€ 594,64

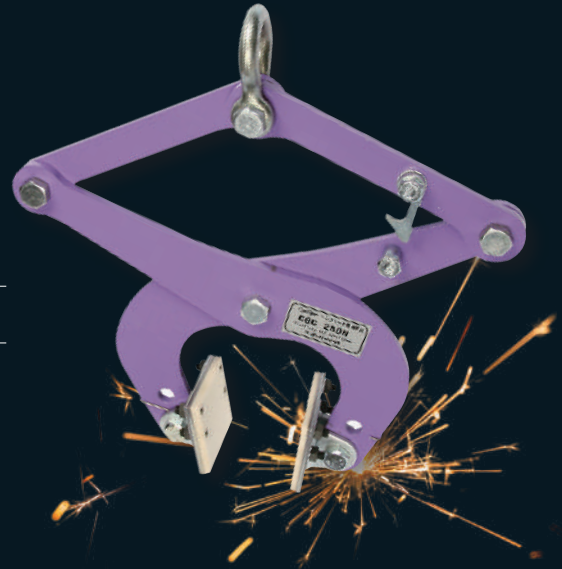

PINZA AMCN

PER MANUFATTI/BLOCCHI
SUPERFICI DI PRESA PROTETTE



ART.	CODICE	PORTATA kg	APERTURA mm	PESO kg	PREZZO
AMC 250N	190329	250	10 - 240	5,5	€ 389,57
AMC 550N	190336	500	10 - 240	7,5	€ 482,14

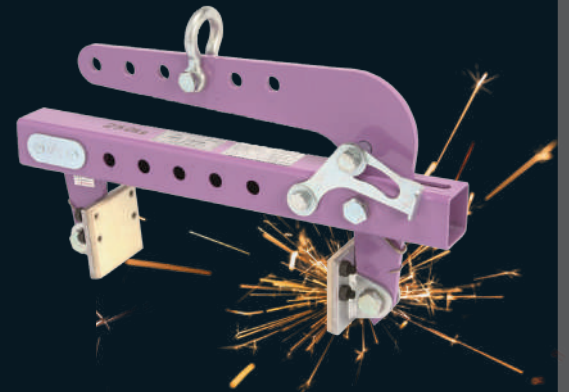

PINZA PTC

PER SOLLEVAMENTO PANNELLI
GANASCE PROTETTE



ART.	CODICE	PORTATA kg	APERTURA mm	PESO kg	PREZZO
PTC 200	222259	200	35 - 135	4,0	€ 474,43
PTC 250	222266	250	80 - 180	5,8	€ 655,71





BILANCINO FLH-1

BILANCINO CON GANCIO PER CARRELLI ELEVATORI

- Il bilancino trasforma un carrello elevatore in una gru mobile
- È sufficiente serrare i bulloni di sicurezza per fissare il bilancino
- Il gancio orientabile provvisto di chiusura di sicurezza garantisce la massima tenuta anche in presenza di vibrazioni.



ART.	CODICE	PORTATA kg	LARGHEZZA mm	SPESSORE mm	PESO kg	PREZZO
FLH-1	179881	1000	70~120	15~40	12,0	€ 478,93



BILANCINO BIG BAGS

ART.	CODICE	PORTATA MAX kg	INTERASSI	PESO kg	PREZZO
BBB2	234573	2000	900x950mm	50,0	€ 1.491,43



BILANCINO BR

ART.	CODICE	PORTATA MAX kg	LUNGHEZZA mm	PESO kg	PREZZO
BR 202	171755	2000	2000	50	€ 1.571,43



* Portate e lunghezze differenti disponibili a richiesta.
Disponibili esecuzioni speciali.

PER SOLLEVAMENTO FUSTI PFUJ



ART.	CODICE	PORTATA kg	FUSTI Ø mm	PESO kg	PREZZO
PFUJ 500	220248	500	600	5,0	€ 176,46



PER SOLLEVAMENTO FUSTI DLC

PER SOLLEVAMENTO FUSTO DAL BORDO

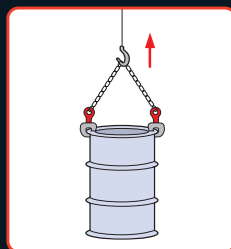

ART.	CODICE	PORTATA kg	APERTURA mm	PESO kg	PREZZO
DLC - 0,5	156592	500	0 - 18	2,0	€ 367,07

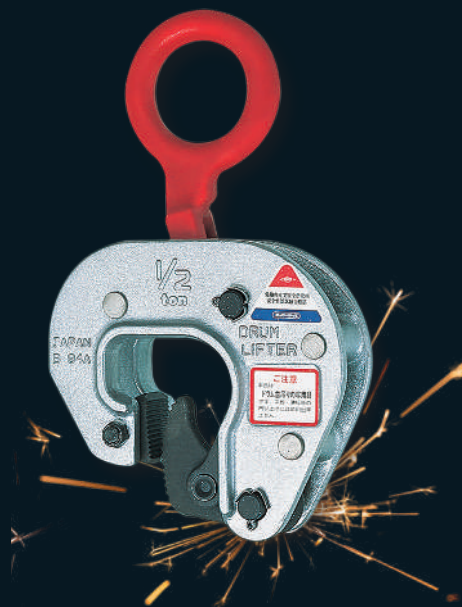

PER SOLLEVAMENTO FUSTI DLC 0,5V

IN POSIZIONE VERTICALE

ART.	CODICE	PORTATA kg	PROFILO mm	PESO kg	PREZZO
DLC - 0,5V	196604	500	2 - 3,5	9,0	€ 598,50





DINAMOMETRO ELETTRONICO D1JT

COMPATTO E LEGGERO - TELECOMANDO INCLUSO

ART.	CODICE	PORTATA MAX kg	SENSIBILITÀ kg	PESO kg	PREZZO
D1JT 3	209441	3000	1	13,0	€ 628,39
D1JT 5	209458	5000	1	16,0	€ 844,07
D1JT 10	209465	10000	5	22,0	€ 1.023,43

MINI DINAMOMETRO ELETTRONICO

- Leggero e compatto
- Maneggevole
- Telecomando incluso
- Gancio girevole
- Funzione stand-by

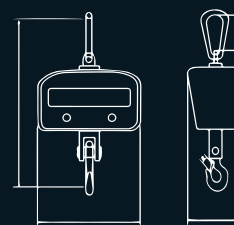

ART.	CODICE	PORTATA MAX kg	PESO kg	PREZZO
D1-0,2 MINI	226608	200	2,5	€ 129,86
D1-0,3 MINI	226615	300	3,0	€ 142,84
D1-0,5 MINI	226622	500	3,5	€ 157,11
D1-1 MINI	226639	1000	4,5	€ 260,04

DINAMOMETRO ELETTRONICO 3 IN 1

3 DIFFERENTI SENSIBILITÀ A SECONDA DEL PESO SOLLEVATO - TELECOMANDO INCLUSO

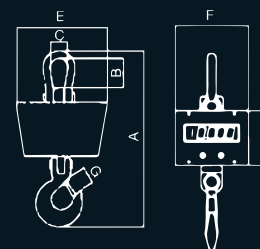

ART.	CODICE	PORTATA MAX kg	SENSIBILITÀ kg	PESO kg	PREZZO
D131 3000	226585	600/1500/3000	0,2/0,5/1	10,5	€ 666,00
D131 6000	218801	1500/3000/6000	0,5/1/2	12,9	€ 871,07
D131 10000	226592	3000/6000/10000	1/2/5	21,0	€ 1.042,07

TIRANTE IN CATENA TC2

TIRANTI A DUE BRACCI
GRADO 80

Completo di campanella, ganci accorciatori e ganci con sicurezza. Ganci self-locking disponibili a richiesta.



ART.	LUNGHEZZA mt	PORTATA 0 - 45°	PORTATA 45° - 60°	CATENA Ø mm	PREZZO
TC 271A	1	2120	1500	7	€ 105,43
TC 281A	1	2800	2000	8	€ 118,29
TC 2101A	1	4250	3150	10	€ 186,43
TC 2131A	1	7500	5300	13	€ 318,86
TC 272A	2	2120	1500	7	€ 138,86
TC 282A	2	2800	2000	8	€ 159,43
TC 2102A	2	4250	3150	10	€ 245,57
TC 2132A	2	7500	5300	13	€ 408,86

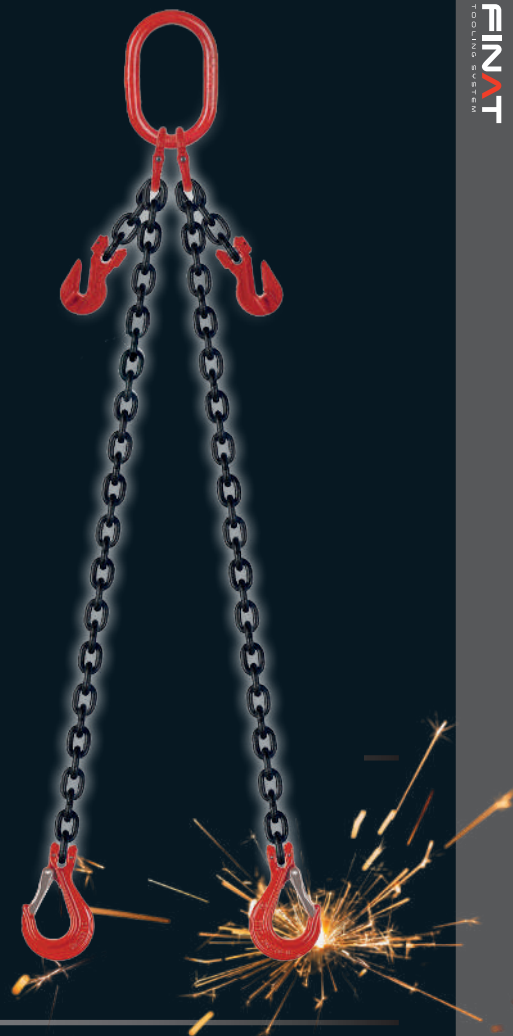

TIRANTE IN CATENA TC4

TIRANTE A QUATTRO BRACCI
GRADO 80

Completo di campanella, ganci accorciatori e ganci con sicurezza. Ganci self-locking disponibili a richiesta.



ART.	LUNGHEZZA mt	PORTATA 0 - 45°	PORTATA 45° - 60°	CATENA Ø mm	PREZZO
TC 471A	1	3150	2240	7	€ 231,43
TC 481A	1	4250	3000	8	€ 270,00
TC 4101A	1	6700	4750	10	€ 388,29
TC 4131A	1	11.200	8000	13	€ 660,86
TC 472A	2	3150	2240	7	€ 298,29
TC 482A	2	4250	3000	8	€ 352,29
TC 4102A	2	6700	4750	10	€ 506,57
TC 4132A	2	11.200	8000	13	€ 840,86



FASCE SOLLEVAMENTO FS

POLIESTERE DOPPIA ASOLA

Coefficiente sicurezza 7:1

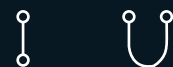

ART.	CODICE	LUNGH. mt	COLORE	PORTATA kg	PORTATA kg	PREZZO
FS-VI-1	220835	1	Verde	1000	2000	€ 2,75
FS-VI-2	220842	2	Verde	1000	2000	€ 4,93
FS-VI-3	220859	3	Verde	1000	2000	€ 7,14
FS-VI-4	220866	4	Verde	1000	2000	€ 9,36
FS-VE-2	220897	2	Verde	2000	4000	€ 9,74
FS-VE-3	220903	3	Verde	2000	4000	€ 13,98
FS-VE-4	220910	4	Verde	2000	4000	€ 18,25
FS-VE-5	220927	5	Verde	2000	4000	€ 22,53
FS-GI-3	220958	3	Giallo	3000	6000	€ 21,10
FS-GI-4	220965	4	Giallo	3000	6000	€ 27,48
FS-GI-6	220989	6	Giallo	3000	6000	€ 40,92

ANCORAGGIO GANCIO UNCINO AU

TENDITORE A CRICCHETTO

ART.	CODICE	LARGH. mm	PORTATA kg	LUNGH. mt	PREZZO
AU 3514	218269	35	1000	4	€ 9,71
AU 3516	218276	35	1000	6	€ 10,45
AU 3518	218283	35	1000	8	€ 12,05
AU 5028,5	218290	50	2000	8,5	€ 18,45
AU 5029,5	218306	50	2000	9,5	€ 19,29
AU 50258,5	218313	50	2500	8,5	€ 19,16
AU 50259,5	218320	50	2500	9,5	€ 19,86
AU 502510,5	218337	50	2500	10,5	€ 20,64

PARANCO PC

PARANCO MANUALE A CATENA

- Gancio con linguetta a molla
- Doppio sistema automatico di freno
- Scorrimento su cuscinetti

PC 1,0

PORTATA kg ⚡ L m

1000 3+3

cod. 212106 **€ 120,66**

PC 2,0

PORTATA kg ⚡ L m

2000 3+3

cod. 212113 **€ 171,00**

PC 3,0

PORTATA kg ⚡ L m

3000 3+3

cod. 212120 **€ 207,00**

PARANCO PCE

PARANCO MANUALE A CATENA

- Gancio con linguetta a molla

PCE 0,5

PORTATA kg ⚡ L m

500 3+3

cod. 212151 **€ 92,44**

PCE 1,0

PORTATA kg ⚡ L m

1000 3+3

cod. 212168 **€ 102,66**

PCE 2,0

PORTATA kg ⚡ L m

2000 3+3

cod. 212175 **€ 146,25**

PARANCO PL

PARANCO A LEVA

- Freno automatico

PL 0,75

PORTATA kg ⚡ L m

750 1,5

cod. 212069 **€ 153,90**

PL 1,5

PORTATA kg ⚡ L m

1500 1,5

cod. 212076 **€ 209,57**

PL 3

PORTATA kg ⚡ L m

3000 1,5

cod. 212083 **€ 298,29**

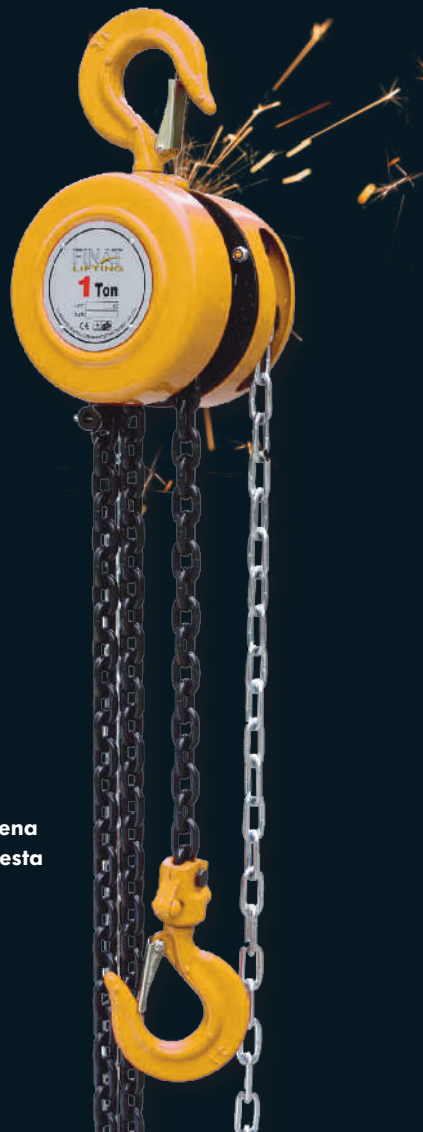
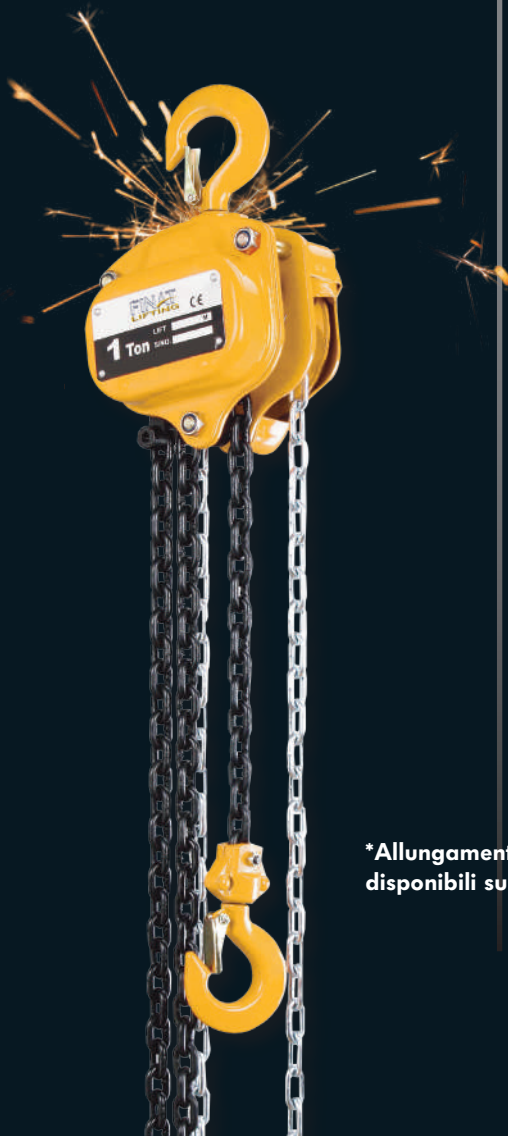

*Allungamenti catena disponibili su richiesta





ALZATIRA A LEVA PLM

VERSIONE MINI

ART.	CODICE	PORTATA MAX kg	L. CATENA mt	PESO kg	PREZZO
PLM 0,25	225038	250	1	2,0	€ 133,07
PLM 0,5	225045	500	1,5	3,0	€ 153,77



CARRELLO PORTA PARANCO CPP

A SPINTA

ART.	CODICE	PORTATA kg	APERTURA mm	PESO kg	PREZZO
CPP 0,5	225052	500	50 - 220	8,2	€ 120,34
CPP 1	226394	1000	58 - 220	10,3	€ 145,67
CPP 2	226400	2000	66 - 220	17,5	€ 221,79

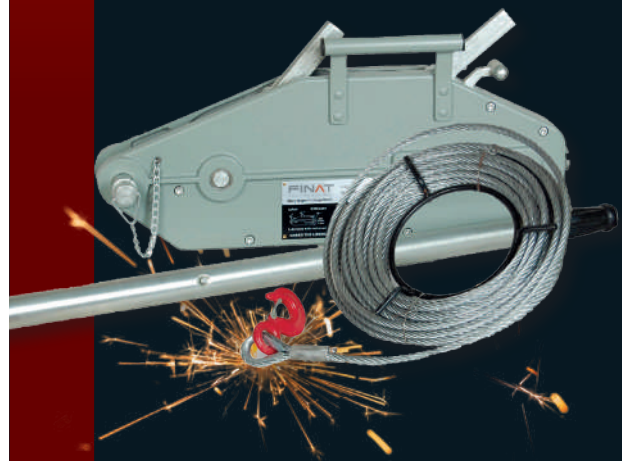

ARGANO FUNE PASSANTE AFP

ART.	CODICE	PORTATA kg	LUNGH. FUNE mt	PESO kg	PREZZO
AFP 0,8	226547	800	20	6,5	€ 175,07
AFP 1,6	226554	1600	20	12,0	€ 250,39
AFP 3,2	226561	3200	20	23,0	€ 430,55

AGGRAFFATORE MAGNETICO C3

ART.	CODICE	CARICO LAVORO kg	PESO kg	PREZZO
C3	212663	75	1,5	€ 95,91



IMPUGNATURA MAGNETICA IMB

A BATTERIA - CARICATORE INCLUSO

ART.	CODICE	CARICO LAVORO kg	PESO kg	PREZZO
IMB 30	223669	30	1,8	€ 443,79
IMB 50	223676	50	2,7	€ 481,11



AGGRAFFATORE N-25

PER IL SUO MINIMO PESO ED INGOMBRO
È PARTICOLARMENTE ADATTO PER L'USO SU SPESSORI SOTTILI

ART.	CODICE	PORTATA kg	PESO kg	PREZZO
N-25	212670	250	5,0	€ 317,23



SOLLEVATORE MAGNETICO SBNN-NEODIMIO

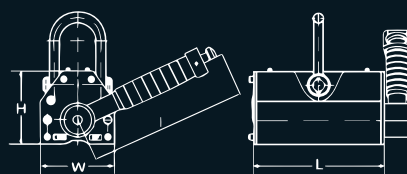

**BASTA
UNA SOLA
MANO!!!**

**LAVORA IN
SICUREZZA! SISTEMA
DI BLOCCO/
SBLOCCO TRAMITE
PULSANTE IN TESTA
ALLA LEVA.**

SI DISTINGUONO PER LA LORO MANEGGEVOLEZZA, PRATICITÀ E SICUREZZA.

Si evita inoltre l'imbragatura dei pezzi da sollevare o l'uso di catene che può danneggiare gli spigoli del carico. Sfruttando il principio del "bipolarismo" il medesimo attrezzo può sollevare pezzi piani e tondi. Molto indicato per barre, tondi, putrelle, blocchi ossitagliati, stampi ecc.

ART.	CODICE	W	L	H	I	PORTATA kg	PESO kg	PREZZO
SBNN-1	203234	62	92	70	145	100	3,0	€ 164,00
SBNN-3	203241	92	162	96	180	300	10,0	€ 325,00
SBNN-5	203258	120	216	116	220	500	21,0	€ 545,00
SBNN-10	203265	176	258	163	285	1000	50,0	€ 1.115,00
SBNN-20	203272	234	378	212	465	2000	125,0	€ 2.000,00

*Per un corretto utilizzo, consultare tabella tecnica disponibile sul catalogo generale FINAT

SOLLEVATORE MAGNETICO MAGNUM-NEODIMIO



MAGGIORE
COEFFICIENTE DI
SICUREZZA!

ART.	CODICE	A	W	L	H	I	PORTATA kg	PESO kg	PREZZO
MAGNUM 1	230001	8	64	92	73	142	100	3,6	€ 328,18
MAGNUM 3	230018	10	88	165	99	176	300	11	€ 598,82
MAGNUM 5	230025	16	118	216	122	219	500	24,5	€ 955,93
MAGNUM 10	230032	20	168	264	170	266	1000	56	€ 1.709,36

SOLLEVATORE MAGNETICO MAGNUM-D NEODIMIO

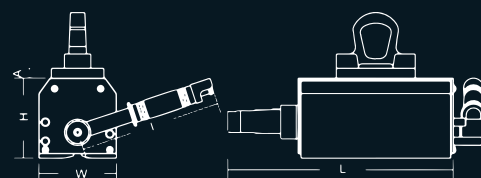

MAGGIORE
COEFFICIENTE DI
SICUREZZA!

ART.	CODICE	A	W	L	H	I	PORTATA kg	PORTATA kg	PESO kg	PREZZO
MAGNUM-D3	230063	10	88	165	99	176	300	60	11	€ 653,14
MAGNUM-D5	230070	16	118	216	122	219	500	100	25	€ 1.042,71
MAGNUM-D10	230087	20	168	264	170	266	1000	200	57	€ 1.864,28

*Per un corretto utilizzo, consultare tabella tecnica disponibile sul catalogo generale FINAT





Prezzi al pubblico IVA esclusa. Menzionare sempre "ordine promo industria 2024". NON verranno emesse note credito per mancata segnalazione.

STRETTOIO SL

STRETTOIO A VITE
25x12

ART.	CODICE	APERTURA/ SCARTAMENTO mm	PREZZO
SL 25	188418	250 x 120	€ 23,86
SL 30	188425	300 x 140	€ 29,71
SL 40	188432	400 x 120	€ 34,29
SL 50	188449	500 x 120	€ 36,71
SL 60	188456	600 x 120	€ 38,71

STRETTOIO VITE PROTETTA "POTENTE" SL-VPP

UTILIZZABILI IN AMBIENTI POLVEROSI E IN PRESENZA DI FLUIDI
35x8

ART.	CODICE	APERTURA / SCARTAMENTO mm	PREZZO
SL30-VPP	223836	300 x 107	€ 35,71
SL40-VPP	223843	400 x 107	€ 38,93
SL50-VPP	223850	500 x 107	€ 41,21
SL60-VPP	223867	600 x 107	€ 44,36
SL250-VPP	223928	2500 x 125	€ 137,07
SL300-VPP	223935	3000 x 125	€ 153,00

STRETTOIO SR

STRETTOIO A LEVA RAPIDA
25x12

ART.	CODICE	APERTURA/ SCARTAMENTO mm	PREZZO
SR 30	188081	300 x 140	€ 57,34
SR 40	188098	400 x 120	€ 59,66
SR 50	188104	500 x 120	€ 61,97
SR 60	188111	600 x 120	€ 64,93

STRETTOIO SM

STRETTOIO A VITE
30x15

ART.	CODICE	APERTURA/ SCARTAMENTO mm	PREZZO
SM 40	188234	400 x 120	€ 61,86
SM 50	188180	500 x 120	€ 68,86
SM 60	188241	600 x 120	€ 72,43
SM 80	188197	800 x 120	€ 82,71
SM 100	188203	1000 x 120	€ 91,71

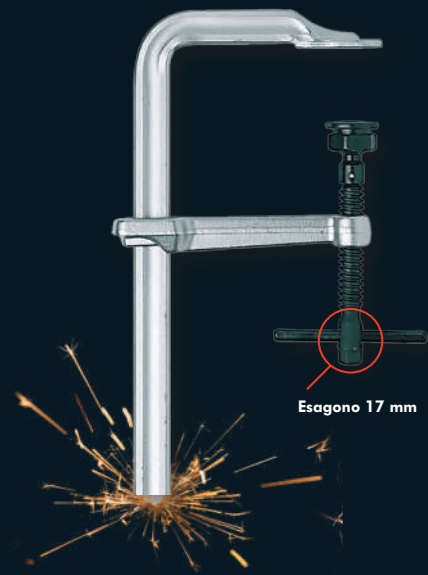

STRETTOIO SMP

STRETTOIO A VITE SCARTAMENTO PROFONDO
30x15

ART.	CODICE	APERTURA/ SCARTAMENTO mm	PREZZO
SMP 40	221924	400 x 250	€ 82,04
SMP 50	221931	500 x 250	€ 88,28
SMP 60	221948	600 x 250	€ 94,39
SMP 80	221955	800 x 250	€ 107,01
SMP 100	221962	1000x 250	€ 120,24

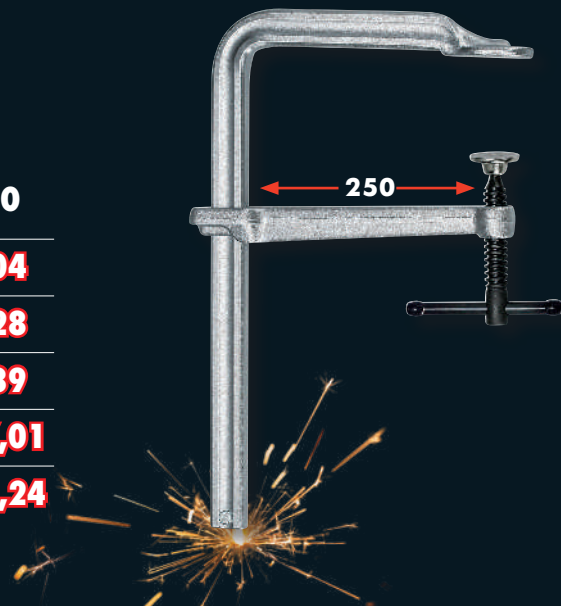

STRETTOIO SP

STRETTOIO A VITE LAVORAZIONI PESANTI
40x20

ART.	CODICE	APERTURA / SCARTAMENTO mm	PREZZO
SP 30	188258	300 x 175	€ 121,95
SP 50	188272	500 x 175	€ 139,63
SP 100	188302	1000 x 175	€ 216,00
SP 150	188326	1500 x 175	€ 281,25





STRETTOIO A BARRA DENTATA T257

PER LAVORAZIONI ULTRA PESANTI
51x22

ART.	CODICE	APERTURA/ SCARTAMENTO mm	PREZZO
T257-450	223270	450 x 115	€ 604,95
T257-600	223287	600 x 115	€ 646,34
T257-900	223294	900 x 115	€ 732,86



STRETTOIO SLC

SERIE A CRICCHETTO
25x12

Riesce a serrare anche in spazi e situazioni impossibili!

ART.	CODICE	APERTURA/ SCARTAMENTO mm	PREZZO
SLC 30	210614	300x140	€ 53,74
SLC 40	210621	400x120	€ 57,21
SLC 50	210638	500x120	€ 61,26
SLC 60	210720	600x120	€ 64,99



STRETTOIO SMC

SERIE A CRICCHETTO
30x15

Riesce a serrare anche in spazi e situazioni impossibili!

ART.	CODICE	APERTURA/ SCARTAMENTO mm	PREZZO
SMC 40	210652	400x120	€ 91,03
SMC 50	210669	500x120	€ 96,88
SMC 60	210676	600x120	€ 103,37
SMC 80	210683	800x120	€ 116,04

STRETTOIO AVVICINAMENTO RAPIDO VELOCE SAR-V

VELOCITÀ DI SERRAGGIO

ART.	CODICE	APERTURA / SCARTAMENTO mm	PREZZO
SAR150-V	222792	150 x 80	€ 22,69
SAR300-V	222808	300 x 80	€ 23,79
SAR450-V	222815	450 x 80	€ 27,71



STRETTOIO AVVICINAMENTO RAPIDO "POTENTE" SAR-P

FORZA DI SERRAGGIO 350 KG.

ART.	CODICE	APERTURA / SCARTAMENTO mm	PREZZO
SAR150-P	222754	150 x 95	€ 36,24
SAR300-P	222761	300 x 95	€ 38,20
SAR450-P	222778	450 x 95	€ 40,24
SAR600-P	222785	600 x 95	€ 42,21
SAR900-P	230353	900 x 95	€ 46,48



SUPPORTO TELESCOPIO BT

PORTATA 180 KG

ART.	CODICE	ESTENSIONE cm	PESO kg	PREZZO
BT 115	223942	65 - 115	1,4	€ 33,04
BT 180	223959	100 - 180	2,2	€ 40,05
BT 290	223966	160 - 290	2,5	€ 43,07

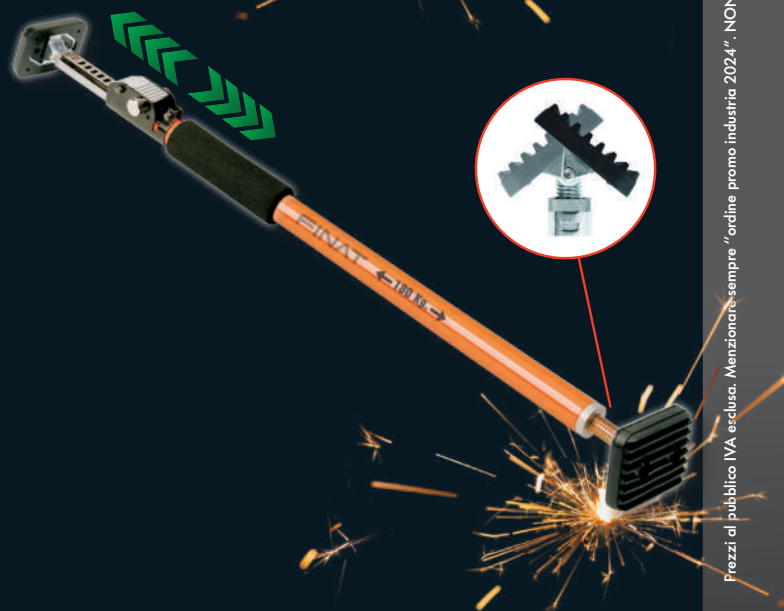

CHIAVE UNIVERSALE A REGOLAZIONE RAPIDA MFW-S

REGOLAZIONE RAPIDA TRAMITE PULSANTE



ART.	CODICE	APERTURA mm	PESO Kg	PREZZO
MFW 280-S	222327	0 - 80	0,49	€ 32,79

CHIAVE HW

CHIAVE A SETTORE UNIVERSALE

REGOLABILE!



ART.	CODICE	APERTURA Ø mm	PREZZO
HW 105	110037	da 35 a 105	€ 39,28
HW 165	110044	da 95 a 165	€ 57,86

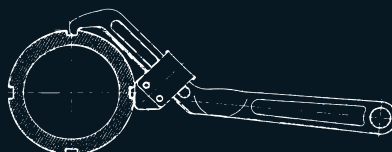

CHIAVE A COMPASSO VARIABILE PW

COMPLETA DI 4 DIAMETRI DI PERNI



ART.	CODICE	APERTURA mm	PESO Kg	PREZZO
PW 100	110051	18 - 100	0,6	€ 92,96

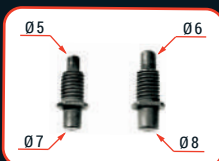

PINZA GRIP SG

PINZA A SCATTO

ART.	CODICE	APERTURA/ SCARTAMENTO mm	PREZZO
SG 225	205504	50 x 30	€ 32,94
SG 250	202985	85 x 60	€ 37,44



APERTURA A SCATTO
VERSO IL BASSO

PINZA GRIP SG-CS

PINZA A SCATTO CON TESTINE A "C" ORIENTABILI

ART.	CODICE	APERTURA / SCARTAMENTO mm	PREZZO
SG 200 CS	224093	125 x 70	€ 24,11



APERTURA A SCATTO
VERSO IL BASSO

PINZA GRIP SG-L

PINZA A SCATTO "BECCO" LUNGO

ART.	CODICE	APERTURA/ SCARTAMENTO mm	PREZZO
SG 200 L	187640	75 x 95	€ 34,89



APERTURA A SCATTO
VERSO IL BASSO



MORSA MOE

MORSA PARALLELA

- Fusione acciaio
- Totale assenza di saldature
- Ganasce sostituibili

ART.	CODICE	LARGHEZZA GANASCE mm	PESO kg	PREZZO
MOE 100	211338	100	5,0	€ 86,53
MOE 125	211345	125	7,6	€ 105,75
MOE 150	211352	150	14,0	€ 144,06



MORSA MOP

MORSA PARALLELA

- Fusione acciaio
- Totale assenza di saldature
- Ganasce sostituibili

ART.	CODICE	LARGHEZZA GANASCE mm	PESO kg	PREZZO
MOP 100	211277	100	7,7	€ 103,56
MOP 125	211284	125	12,0	€ 126,06
MOP 150	211291	150	15,0	€ 177,43

MORSA MOI-T

MORSA PARALLELA CON GANASCE SERRATUBO

- Fusione acciaio
- Totale assenza di saldature
- Ganasce sostituibili

ART.	CODICE	LARGHEZZA GANASCE mm	PESO kg	PREZZO
MOI 100 T	210843	100	7,5	€ 179,36
MOI 125 T	210850	125	13,4	€ 206,36
MOI 150 T	210867	150	17,7	€ 261,00

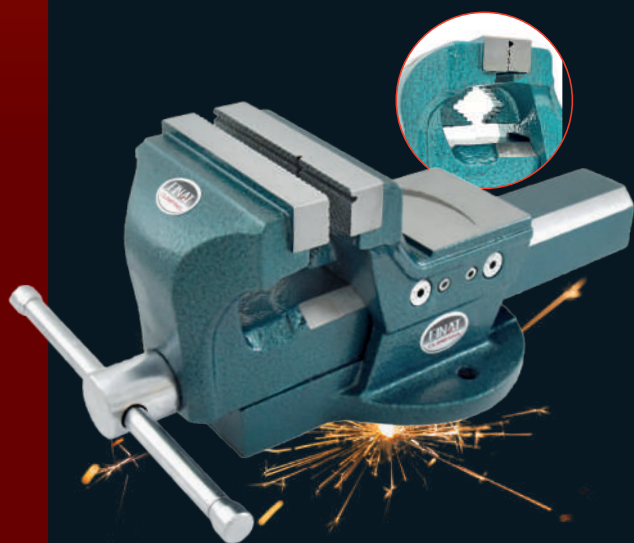

MORSA MOCR

MORSA PARALLELA CODA DI RONDINE

- Fusione acciaio
- Totale assenza di saldature
- Ganasce sostituibili



ART.	CODICE	LARGHEZZA GANASCE mm	PESO kg	PREZZO
MOCR 150	211970	150	19,0	€ 308,25

MORSA SO 90°

MORSA PER SERRARE IN SQUADRA

Struttura in ghisa, vite ramata, doppio snodo.

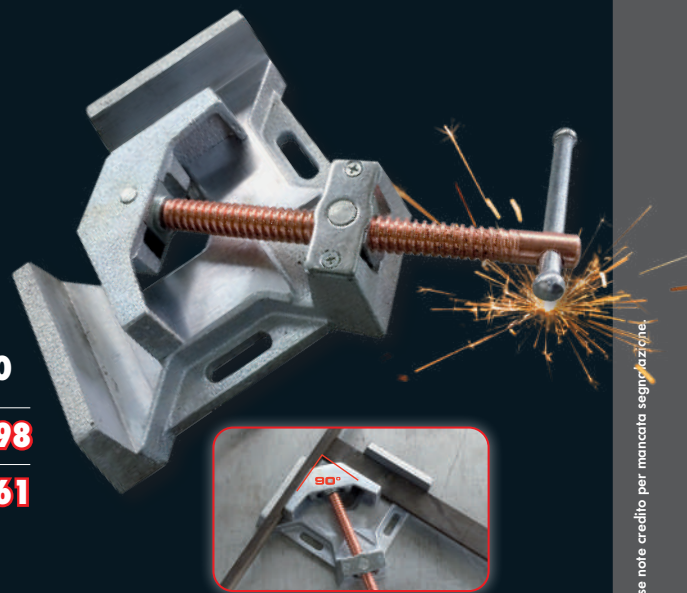

ART.	CODICE	CAPACITÀ mm	ALTEZZA mm	LUNGHEZZA mm	PREZZO
SO 90	191142	2 x 90	35	110	€ 131,98
SO 120	220460	2 x 120	60	110	€ 186,61

MORSA DA TRAPANO MOTR-AR

SISTEMA AVVICINAMENTO RAPIDO



ART.	CODICE	LARGHEZZA GANASCE mm	PESO Kg	PREZZO
MOTR-AR 100	222495	100	5,4	€ 236,14

HH 350

SERIE ORIZZONTALE

Fornito con puntale in neoprene.
TUTTI I RIVETTI SONO IN ACCIAIO INOX

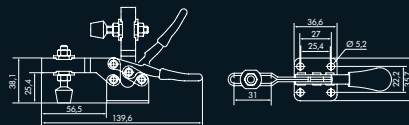

ART.	CODICE	PORTATA kg	PESO g	PREZZO
HH 350	148498	90	125	€ 18,29

HH 500

SERIE ORIZZONTALE

Fornito con puntale in neoprene.
Tutti i rivetti sono in acciaio inox.

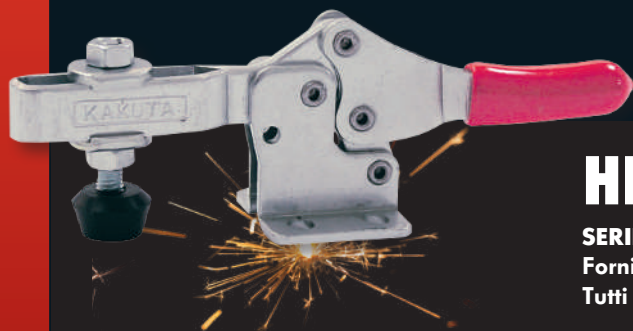
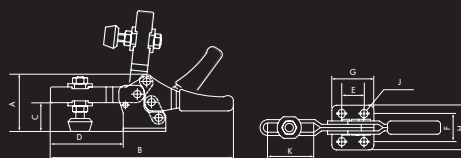

ART.	CODICE	PORTATA kg	PESO g	PREZZO
HH 500	159500	227	322	€ 25,14

HV 250-U

SERIE VERTICALE

Fornito con puntale in neoprene.
Tutti i rivetti sono in acciaio inox.

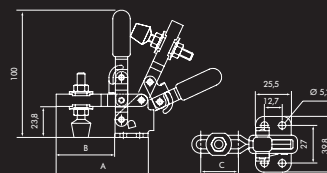

ART.	CODICE	PORTATA kg	PESO g	PREZZO
HV 250-U	159524	90	167	€ 17,79

HV 450

SERIE VERTICALE

Fornito con puntale in neoprene.
Tutti i rivetti sono in acciaio inox.

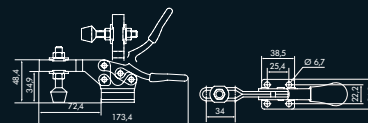

ART.	CODICE	PORTATA kg	PESO g	PREZZO
HV 450	148658	225	350	€ 19,86

DISEGNI TECNICI E TABELLE CONSULTABILI SUL CATALOGO GENERALE FINAT .
DISPONIBILI A RICHIESTA, PER L'INTERA GAMMA 'BLOCCAGGI RAPIDI', FILE STEP/3D .

FA 200

SERIE A TIRANTE

Piastra di riscontro inclusa.

Tutti i rivetti sono in acciaio inox.

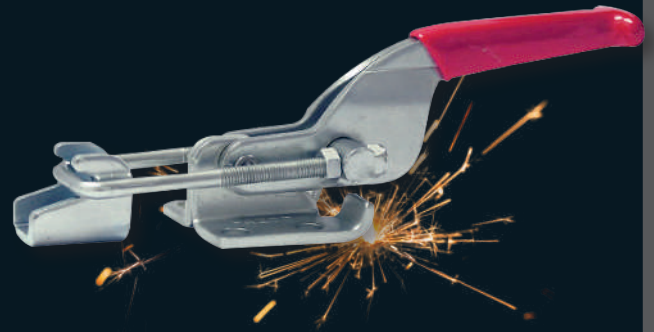
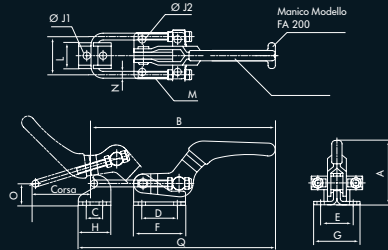

ART.	CODICE	PORTATA kg	CORSA	PESO g	PREZZO
FA 200	148818	320	48	215	€ 26,79

PA 350

SERIE A TIRANTE

Per la chiusura di coperchi e coperture di cisterne o serbatoi.

Uncino regolabile in lunghezza.
Tutti i rivetti sono in acciaio inox.

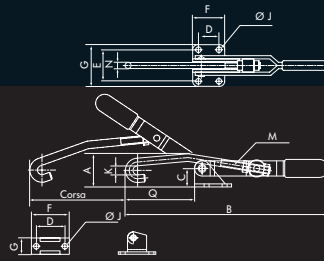

ART.	CODICE	PORTATA kg	CORSA	PESO g	PREZZO
PA 350	178785	450	140	1130	€ 46,86

SL 100

SERIE CON ASTA A SPINTA

Molto potente.

Corpo in fusione di acciaio.

Tutti i rivetti sono in acciaio inox.

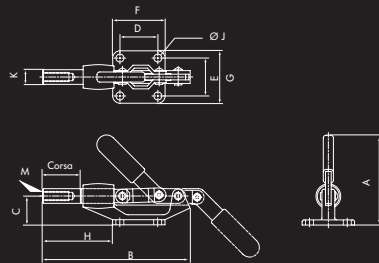

ART.	CODICE	PORTATA kg	CORSA	PESO g	PREZZO
SL 100	148849	220	30,2	306	€ 35,43

FM 150

SERIE CON ASTA A SPINTA

Possibilità di rotazione a 360°.

Per questo è ampiamente utilizzato sia in fase di spinta che di trazione.

Tutti i rivetti sono in acciaio inox.

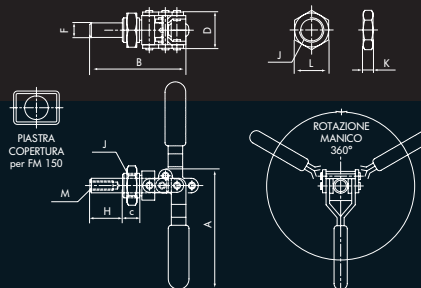

ART.	CODICE	PORTATA kg	CORSA	PESO g	PREZZO
FM 150	148825	150	38,1	260	€ 27,64

DISEGNI TECNICI E TABELLE CONSULTABILI SUL CATALOGO GENERALE FINAT .
DISPONIBILI A RICHIESTA, PER L'INTERA GAMMA 'BLOCCAGGI RAPIDI', FILE STEP/3D .



SMERIGLIATRICE CV-GN 1/4'' Mini

- Impugnatura confortevole e leva con sicura
- Regolazione aria in testa
- Innesto aria rotante
- Bassa rumorosità 77 dB(A)

ART.	CODICE	VELOCITÀ LIBERA g/min	ASSORB. ARIA L/min	PRESSIONE ARIA Mpa	ATTACCO ARIA	Ø TUBO ARIA mm	LUNGH. TOTALE mm	GRADO RUMORE	PINZA Ø mm	PESO gr
CV-GN 1/4'' Mini	211635	25000	113	6,2	1/4''	6,35	159	77	6	400

PREZZO € 85,31



SMERIGLIATRICE CV-GNE 1/4'' EXT

STELO PROLUNGATO

- Impugnatura confortevole e leva con sicura
- Regolazione aria in testa e innesto aria rotante
- Bassa rumorosità 77 dB(A)

ART.	CODICE	VELOCITÀ LIBERA g/min	ASSORB. ARIA L/min	PRESSIONE ARIA Mpa	ATTACCO ARIA	Ø TUBO ARIA mm	LUNGH. TOTALE mm	GRADO RUMORE	PINZA Ø mm	PESO gr
CV-GNE 1/4'' EXT	211642	25000	113	6,2	1/4''	6,35	256	77	6	700

PREZZO € 116,74



SMERIGLIATRICE A NASTRO CV-GNN 13

- Impugnatura confortevole e leva con sicura
- Silenziato
- Innesto aria rotante

ART.	CODICE	DIMENSIONI NASTRO	VELOCITÀ LIBERA g/min	ASSORB. ARIA L/min	PRESSIONE ARIA Mpa	ATTACCO ARIA	LUNGH. TOTALE mm	PESO gr
CV-GNN 13	211697	13 x 330	20000	119	6,2	1/4''	331	850

PREZZO € 206,68

SMERIGLIATRICE ANGOLARE CV-GNA 5 E

- Regolatore di velocità, con sicura a leva
- 1,6 HP
- Scarico aria posteriore



ART.	CODICE	DISCO Ø mm	VELOCITÀ LIBERA g/min	ASSORB. ARIA L/min	PRESSIONE ARIA Mpa	ATTACCO ARIA	LUNGH. TOTALE mm	PESO gr	PREZZO
CV-GNA 5 E	211628	125	12000	113	6,2	1/4"	239	2000	€ 278,36

SMERIGLIATRICE ANGOLARE CV-GNA 7

- Regolatore di velocità
- Con sicura a leva
- 2,2 HP



ART.	CODICE	DISCO Ø mm	VELOCITÀ LIBERA g/min	ASSORB. ARIA L/min	PRESSIONE ARIA Mpa	ATTACCO ARIA	LUNGH. TOTALE mm	PESO gr	PREZZO
CV-GNA 7	211611	180	8400	133	6,2	3/8"	323	3400	€ 716,78

PISTOLA DI SOFFIAGGIO AD-2-E

CON UGELLO IN ACCIAIO

ART.	CODICE	DIM. UGELLO mm	PRESSIONE ESERCIZIO	PREZZO
AD-2-50E	203470	50 x ø 3	0~10 Bar	€ 7,71
AD-2-100E	203463	100 x ø 3	0~10 Bar	€ 8,71





AVVITATORE CV-W 3/8"

AVVITATORE AD IMPULSO DOPPIA MASSA BATTENTE

ART.	CODICE	COPPIA Nm	PRESSIONE ARIA Mpa	VELOCITÀ LIBERA g/min	GRADO RUMORE	ASSORB. ARIA L/min	ATTACCO ARIA	LUNGH. TOTALE mm	ATTACCO	PESO gr
CV-W 3/8"	211451	583	6,2	11000	83	113	1/4"	153	3/8" □	1200

PREZZO € 197,68



AVVITATORE CV-W 1/2" COMPACT

AVVITATORE AD IMPULSO DOPPIA MASSA BATTENTE
Compatto e potente

ART.	CODICE	COPPIA Nm	PRESSIONE ARIA Mpa	VELOCITÀ LIBERA g/min	GRADO RUMORE	ASSORB. ARIA L/min	ATTACCO ARIA	LUNGH. TOTALE mm	ATTACCO	PESO gr
CV-W 1/2" Compact	211505	678	6,2	10000	83	113	1/4"	1200	1/2" □	1540

PREZZO € 179,68



AVVITATORE CV-W 3/4"

AVVITATORE AD IMPULSO DOPPIA MASSA BATTENTE

ART.	CODICE	COPPIA Nm	PRESSIONE ARIA Mpa	VELOCITÀ LIBERA g/min	GRADO RUMORE	ASSORB. ARIA L/min	ATTACCO ARIA	LUNGH. TOTALE mm	ATTACCO	PESO gr
CV-W 3/4"	211482	2,034	6,2	5500	90	198	1/4"	215	3/4" □	3300

PREZZO € 520,71

TRAPANO CV-PDR 13

REVERSIBILE

- Compatto
- Selettore 2 velocità
- Silenziatore brevettato 83 db (A)
- 0,5 HP



ART.	CODICE	CAPACITÀ FORO mm	VELOCITÀ LIBERA g/min	ASSORB. ARIA L/min	PRESSIONE ARIA Mpa	ATTACCO ARIA	LUNGH. TOTALE mm	GRADO RUMORE	MANDRINO mm	PESO gr
CV-PDR 13	211598	13	800	-	6,2	1/4"	218	83	13	1300

PREZZO € 215,68

CACCIAVITE CV-S 1/4"

CACCIAVITE IMPACT REVERSIBILE



ART.	CODICE	COPPIA Nm	PRESSIONE ARIA Mpa	VELOCITÀ LIBERA g/min	GRADO RUMORE	ASSORB. ARIA L/min	ATTACCO ARIA	LUNGH. TOTALE mm	ATTACCO	PESO gr
CV-S 1/4"	211536	102	6,2	11000	84	131	1/4"	181	1/4" ○	1000

PREZZO € 179,68

TRONCHESE MANUALE TR

PER TRONCATURA PNEUMATICA DI PLASTICA, ACCIAIO, RAME, INOX

ART.	CODICE	LUNGHEZZA TOTALE mm	CORPO Ø mm	PREZZO
TR20	204736	122	45	€ 316,21
TR30	204743	158	56	€ 408,84

LAME

L 20 P	Plastic	€ 99,07
L 30 GS	Metal	€ 196,45



INSERTI E PORTAINSERTI



CONIATO Phillips®

ART.			PREZZO
F3001/25 C	PH1	25	€ 0,71
F3002/25 C	PH2	25	€ 0,71
F3003/25 C	PH3	25	€ 0,71

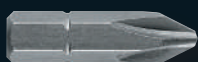

FRESATO Phillips®

ART.			PREZZO
F3001/25	PH1	25	€ 0,77
F3002/25	PH2	25	€ 0,77
F3003/25	PH3	25	€ 0,77



Torx®

ART.			PREZZO
FT 10/25	T10	25	€ 1,41
FT 15/25	T15	25	€ 1,41
FT 20/25	T20	25	€ 1,41
FT 25/25	T25	25	€ 1,41
FT 27/25	T27	25	€ 1,41
FT 30/25	T30	25	€ 1,41



FRESATO Phillips®

ART.			PREZZO
F4301/50	PH1	50	€ 1,86
F4302/50	PH2	50	€ 1,86
F4303/50	PH3	50	€ 2,31

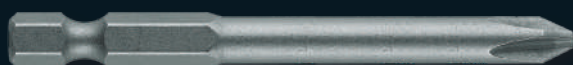

FRESATO Phillips®

ART.			PREZZO
F4301/110	PH1	110	€ 3,02
F4302/110	PH2	110	€ 2,80
F4303/110	PH3	110	€ 3,34



CONIATO Pozidriv®

ART.			PREZZO
F3001/25 PZD C	PZ1	25	€ 0,71
F3002/25 PZD C	PZ2	25	€ 0,71
F3003/25 PZD C	PZ3	25	€ 0,71



FRESATO Pozidriv®

ART.			PREZZO
F3001/25 PZD	PZ1	25	€ 0,77
F3002/25 PZD	PZ2	25	€ 0,77
F3003/25 PZD	PZ3	25	€ 0,77

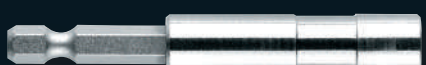

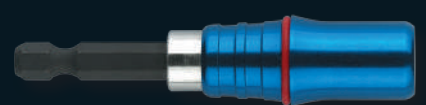

1/4" Magnetico

ART.			PREZZO
F3314/75M	6,35 (1/4")	75	€ 6,49



1/4" Magnetico

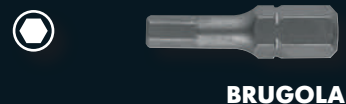

ART.			PREZZO
F3320/71M	6,35 (1/4")	71	€ 9,80

ART.			PREZZO
F3032/25	2	25	€ 1,32
F3032,5/25	2,5	25	€ 1,32
F3033/25	3	25	€ 1,32



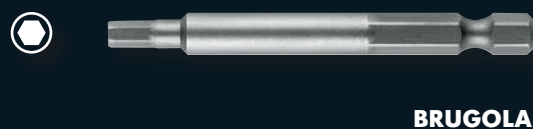

ART.			PREZZO
F1332/70	2	70	€ 2,80
F1333/70	3	70	€ 2,80
F1334/70	4	70	€ 2,80
F1335/70	5	70	€ 2,80
F1336/70	6	70	€ 2,80



ART.			PREZZO
F1308/50	8	50	€ 6,04
F1310/50	10	50	€ 6,33
F1313/50	13	50	€ 7,20



ART.			PREZZO
F1308/75M	8	75	€ 12,37
F1310/75M	10	75	€ 13,05
F1313/75M	13	75	€ 23,91



COLOR BOX 32 PZ.

UN COLORE DIVERSO PER OGNI IMPRONTA!

ARTICOLO	CONTENUTO
COLOR BOX	⊕ 1 pz. PH 1 - 2 pz. PH 2 - 1 pz. PH 3
	⊕ 1 pz. PZD 1 - 2 pz. PZD 2 - 1 pz. PZD 3
	⊕ 1 pz. 3mm, 4mm, 5mm, 6mm
	○ 1 pz. 3mm, 4mm, 5mm, 6mm
	⊕ 1 pz. T10, T15, T20, T25, T27, T30, T40
	⊕ T10, T15, T20, T25, T27, T30, T40
	⊕ 1 Adattatore quadro 1/4" lungh. 65 mm
	⊕ Portainseri Magnetico

**Dal 1961 ci occupiamo di utensili per l'industria.
Da sempre, alla Finat, abbiamo creduto e crediamo fermamente
nell'offrire Qualità senza compromessi.**

Facciamo di passione, competenza, e servizio al cliente, i nostri principi fondamentali.
La nostra organizzazione di tecnici e commerciali ci permette di essere presenti su tutto il territorio nazionale e internazionale, garantendo risposte immediate alle esigenze del mercato e dei nostri rivenditori.

Grazie alla professionalità ed alla competenza che da sempre ci distingue, la Finat si avvale oggi di una rete di oltre 5000 clienti in Italia ed Europa.

L'assistenza post-vendita sui nostri prodotti ci rende un partner sui cui poter contare costantemente; aspetto più che mai fondamentale nella rapida evoluzione del mercato che circonda il mondo dell'industria.

**Scadenza promozione
31.12.2024**

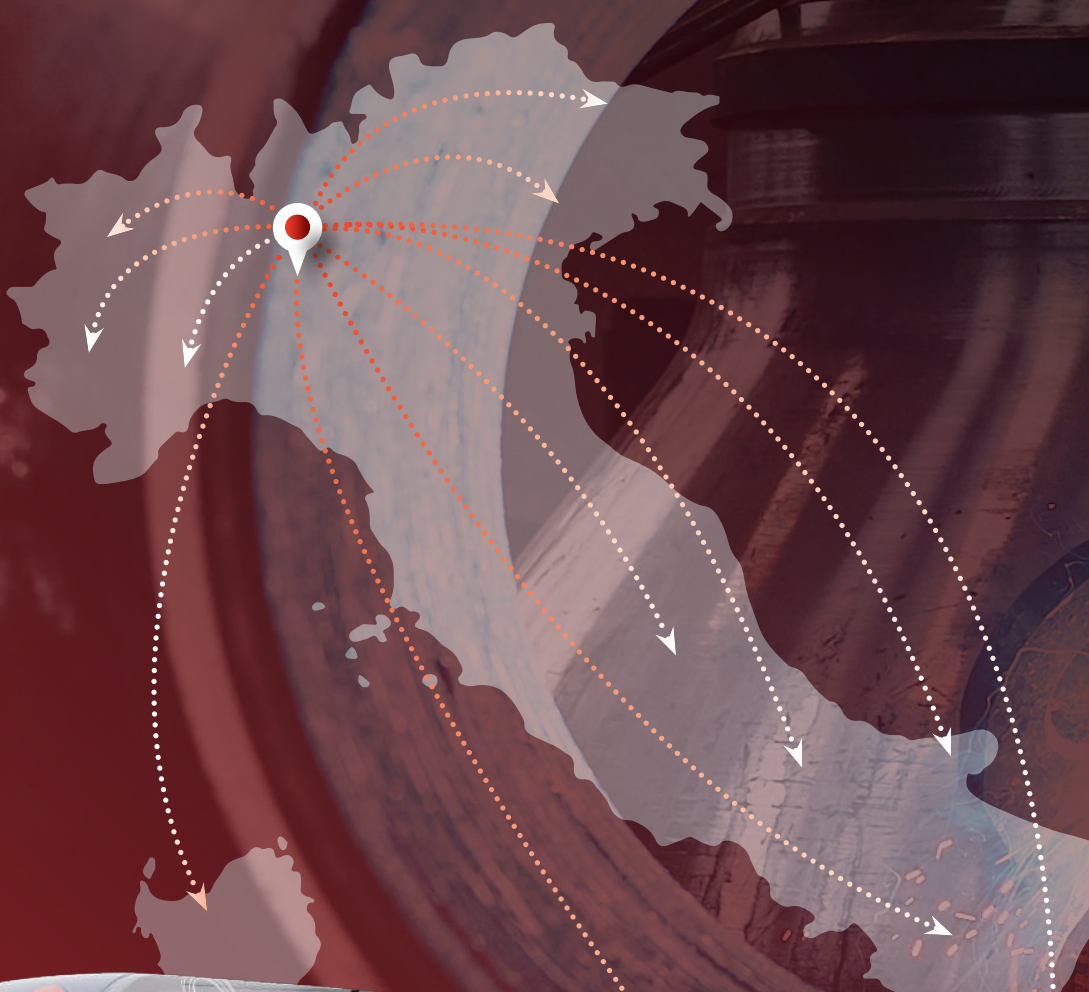

		VITERIA 2000 Srl P. IVA 01398380839
Via Jacopo Linussio, 1 38170 Pordenone [PN] Tel. 0434 630825/6 Fax 0434 638721 info@viteria2000.it www.viteria2000.it	Filiale di Genova Via Giacomo Solliman, 62 16154 Genova [GE] Tel. 348 8908708 genova@viteria2000.it	
Filiale di Ancona Via Guglielmo Marconi, 8 60125 Ancona [AN] Tel. 344 1200215 ancona@viteria2000.it	Filiale di Marghera Via delle Industrie, 23 30175 Venezia VE Tel. 041 937667 info@viteria2000.it	Filiale di Montalcone Via Gallisto Cosulich, 42 54074 Montalcone [GO] Tel. 0481 486512 montalcone@viteria2000.it

**NUOVA FINAT s.r.l. - VIA G. DI VITTORIO 42/48 - 20017 RHO (MI)
Tel. +39 023760141 - E-mail: info@finat.it - www.finat.it**